

Technical Specifications

Materials	Steel
Connections	½" flow and return.
Test pressure	5 Bar
Testing authority	Politecnico di Milano
Maximum operating pressure	3.3 Bar
Maximum working temperature	90°C
Packaging	Wrapped in polythene and boxed
Cleaning	Soft damp cloth with a non abrasive cleaning product

PLEASE NOTE: Systems using micro bore pipework must have adequate pressure and flow rates for the number and style of radiators on the system.

Terms & Conditions

All products must be inspected once removed from the packaging and The Radiator Company notified within 28 days of delivery of any scratches, blemishes or other damage. The Radiator Company will then replace the radiator.

Imperfect radiators should therefore not be fitted and The Radiator Company will not accept responsibility for replacement of scratched or damaged radiators once they have been fitted. This includes any consequential loss or cost of fitting.

If The Radiator Company are not notified within 28 days of the date on the signed delivery note then it will be deemed that The Radiator Company have fully complied with its obligations and claims will not be considered.

Failure to comply with any of the above may invalidate any claims.

We recommend that after you check the product on delivery that it is stored in its packaging to prevent damage prior to installation. The Radiator Company cannot accept responsibility for items damaged after delivery.

Guarantees & Liabilities

As we are not the manufacturers of this product we will take all reasonable endeavours to make over to you the benefit of any warranty or guarantee given by the manufacturer, which is usually five years on most of our range. (Copies of specific guarantees for any of our products are available on request).

The guarantees in all cases are subject to the products being installed in accordance with British and or European standards as well as these fitting instructions. The guarantees in all cases are restricted to the free of charge replacement or repair of the failed product only. Our liability will under no circumstances extend beyond the repair or replacement of the product supplied by us. Claims for either labour in replacement or damage to property are not admissible. Any goods that are returned, in the event of a problem, will belong to The Radiator Company.

Fittings Instructions



The Picchio is a flat, contemporary & stylish radiator suiting almost every environment.

Please read these instructions and terms and conditions carefully prior to installation. Failure to do so may invalidate the warranty.

The Radiator Company
Units 13 - 14 Charlwoods Road
East Grinstead
West Sussex
RH19 2HU



PICCV1.2

Diagrams of Picchio Vertical

305mm wide

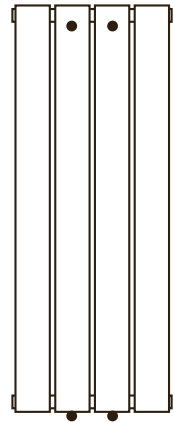

455mm or wider

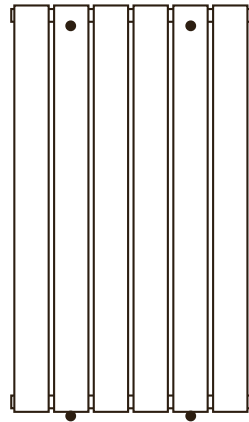

● = typical bracket fixing positions

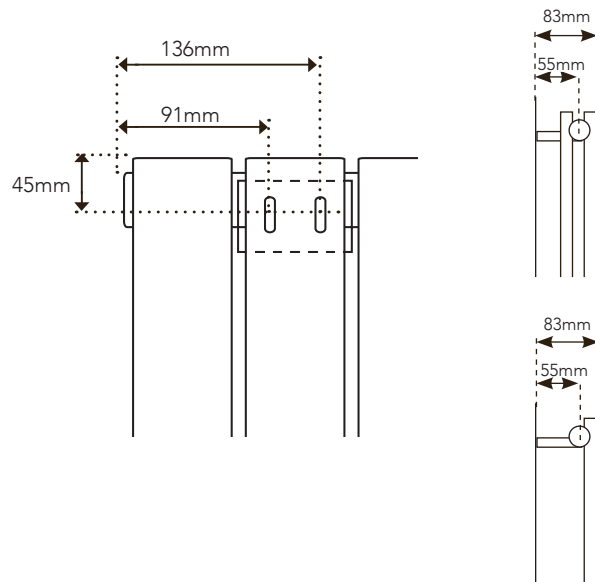

Pipe Centres

	Single width + valves	Double width + valves
Pipe centres left to right =	55mm	55mm
Pipe centres from wall =	83mm	83mm
Depth from wall =		

1 Unpack & Inspect

The Radiator Company prides itself on selecting products from manufacturers who exercise tight quality control measures. We only select models with excellent standards of welding and brazing, as well as high quality finishes. All of our products are well packaged and should reach you in perfect condition. Just in case however, we offer a minimum 5-year no quibble guarantee for all radiators and towel rails.

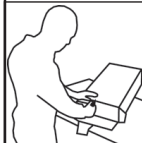

Please carefully unpack and inspect this radiator and all fittings. The Radiator Company must be notified of any shortages or damage within 28 days of delivery. For further information please see terms and conditions on back page.

2 Contents

You should have:

- 1 Radiator
- 4 Wall brackets
- 8 Wall Plugs
- 8 Screws
- 8 Plastic sleeves
- 1 Airvent
- 1 Blanking Plug
- 1 Diverter

You will need:

- Tape measure
- Electric drill and bits
- Spirit level
- 10mm long reach allen key or 10mm hex bit plus long reach driver. (only required if fitting diverter - see step 6).

3 Mark Bracket Positions

The two fixing positions for the two top brackets are measured at 91mm and 136mm in from either end of the top collector and measured down 45mm (please see diagram opposite).

In order to accurately mark the bottom bracket fixing positions we recommend you mark, fix and level the two top brackets first. Then hang the radiator, ensuring it is vertically level and manually hold the bottom brackets in position while marking.

4 Fix Brackets

Using a suitable drill bit, screws and plugs, fix the brackets and level with a spirit level. Please see diagrams.

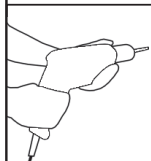

PLEASE NOTE :

It is essential that all brackets are level to ensure a vertical alignment for connecting the pipework.

5 Hang Radiator

With the brackets firmly fixed and level and the plastic sleeves fitted, the radiator is lowered directly onto the brackets.

6 Fitting Diverter & Commission

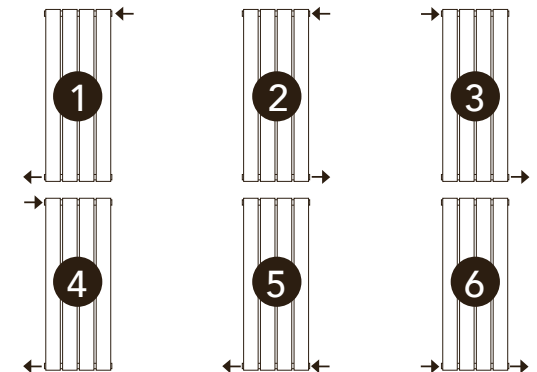

For connection options 1, 2, 3 & 4 the radiator can be commissioned as supplied without the need for the diverter to be installed.

For connection options 5 or 6 you will need to insert the diverter into the collector. The diverter is the threaded nut with a 10mm hex slot contained in the fittings pack. The diverter position is indicated by a coloured label (please see diagram below).



Open collector
as supplied

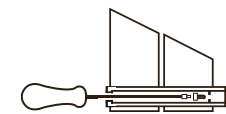

Insert diverter
to close collector

Please Note: In accordance with Part L1 2006 of the Building Regulations and BS7593:1992 code of practice for the treatment of hot water and central heating systems, we strongly recommend flushing the heating system post installation of new radiators and then adding the correct quantity and type of inhibitor for use with your radiator and system to prevent corrosion. Damage caused to systems not protected by a suitable inhibitor will not be covered by manufacturer's guarantee.